

RITM OKB ZAO

TRANSCUTANEOUS ELECTROSTIMULATORS

**SCENAR Home,
SCENAR Sport,
SCENAR Basic**

OPERATING MANUAL



MANUFACTURER

RITM OKB ZAO
99, Petrovskaya str., Taganrog, Russia, 347900
Tel/Fax: +7 (8634) 62-31-79
www.scenar.com.ru e-mail: medsc@scenar.com.ru

AUTHORIZED REPRESENTATIVE

SCENAR Center – Bulgaria Ltd.
9, V. Aprilov blvd. Plovdiv, 4002, Bulgaria
phone: (+3-59-32) 641-001 e-mail: office@bgscenar.org

**IMPORTANT INFORMATION!*****PLEASE READ THIS PAGE CAREFULLY***

WARNING! This device should NOT be used on an individual who has a heart pacemaker or other electrically powered implant fitted.

WARNING! Application of electrodes near the thorax may increase the risk of cardiac fibrillation.

WARNING! Simultaneous connection of a patient to h.f. surgical equipment may result in burns at the site of the stimulator electrodes and possible damage to the stimulator.

WARNING! Operation in close proximity (e.g. 1 m) to shortwave or microwave therapy equipment and mobile communicators may produce instability in the stimulator output.

WARNING! Aged people, children, and people with disabilities may not use the stimulator.

WARNING! The device needs special precautions regarding EMC and needs to be installed and put into service according to the EMC information provided in Annex 1.

WARNING! As the current densities for electrodes exceed 2 mA r.m.s./cm^2 , the device requires the special attention of the user.

WARNING! The device should not be used adjacent to or stacked with other equipment.

This appliance is marked according to the European directive 2002/96/EC on Waste Electrical and Electronic Equipment (WEEE). By ensuring this product is disposed of correctly, you will help prevent potential negative consequences for the environment and human health, which could otherwise be caused by inappropriate waste handling of this product.

The  symbol on the documents accompanying the product indicates that this appliance may not be treated as household waste. Instead it shall be handed over to the applicable collection point for the recycling of electrical and electronic equipment.

Disposal must be carried out in accordance with local environmental regulations for waste disposal.

For more detailed information about treatment, recovery and recycling of this product, please contact your local city office, your household waste disposal service or the shop where you purchased the product.

Origin: RITM OKB ZAO, 99, Petrovskaya str., Taganrog, Rostov region, 347900, Russia.

Model(s): SCENAR Home, SCENAR Sport, SCENAR Basic.

Classification: *Type of protection against electric shock* – Internally powered equipment (9 V battery) *Degree of protection against electric shock* – Type BF.

Waterproofing: No special protection against liquid ingress provided (IPX0).

Cleaning & Disinfecting: Wipe electrode area with a cotton swab dampened with 3 % hydrogen peroxide solution with the addition of 0.5 % solution of an approved cleaning liquid. Allow to dry up thoroughly before use.

Clinical environment: NOT suitable for use in the presence of flammable anaesthetic mixtures with air, oxygen or nitrous oxides.





DO NOT REMOVE the upper casing – this access is for the use of service personnel only.

Batteries: Remove battery from device if not in use for an extended period. Connect correctly.

DO NOT TRY TO RECHARGE disposable batteries! Dispose of used batteries responsibly. Use good quality, within-date long-life, 9 V ALKALINE Type 6F22KG, 1604, 6LR61.

***Note:** Remove battery during storage and transportation to avoid battery drain. Do not operate the device with the battery cover removed, as this exposes the operator to live battery circuits in contravention of the Safety Regulations.*

MARKS AND SYMBOLS ON THE DEVICE LABEL

	<p>THIS CE SYMBOL CERTIFIES THAT THE PRODUCT COMPLIES WITH THE ESSENTIAL REQUIREMENTS OF THE MEDICAL DEVICE DIRECTIVE</p> <p>Notified Body No.2265 3EC International a.s., Hraničná 18, Bratislava, 82105, Slovakia</p>
	<p>APPLIED PARTS – TYPE BF</p>
 <p>RITM OKB ZAO 99 Petrovskaya Str, Taganrog, 347900, RUSSIA 2012</p>	<p>MANUFACTURER combined with DATE OF MANUFACTURE</p>
<p>SN-XXXX</p>	<p>SERIAL NUMBER</p>
	<p>CONSULT INSTRUCTIONS FOR USE</p>
	<p>AUTHORISED REPRESENTATIVE IN THE EUROPEAN COMMUNITY</p>

DEFINITIONS

Amplitude modulation (Am) is a periodic variation of stimuli amplitude (as well as **stimuli Energy**). **Am** is defined as the ratio of the time the device is sending pulses with preset **Energy** to that with minimal **Energy**. For example, the '3:1' **Am** setting indicates that the device is transmitting **stimuli** with preset **Energy** for 3 seconds and then with **Energy** = 1 for 1 second. **Amplitude modulation** manifests itself as strengthening and weakening the specific sensations with a set period.

Dose is a signal to the operator that the rate of skin **impedance** change has sufficiently reduced.

Dosed Stimulation determines the type of dosing provided by the device. When the **Dosed Stimulation** is switched ON, the stimulation time for a zone is determined automatically. When the **Dosed Stimulation** is switched OFF, the zones to be treated, stimulation time for each zone and time of the whole session are determined by the therapist.

Energy is a parameter determining strength of every stimulus. The **Energy** influences **stimulus** amplitude and strength of stimulation sensation. The higher the **Energy**, the stronger the specific sensations felt by the patient.

Electrodes are cutaneous electrodes (built-in electrode and add-on electrodes) that are applied directly to patient's skin for electrical stimulation.

Frequency (F) is a number of **stimuli** (or **stimuli** bursts) per second, measured in Hertz (Hz). When **Frequency** changes the strength and 'volume' of sensations also change.

Frequency modulation (Fm) is a periodical change of **stimuli Frequency** from initial to final **Frequency** value and back. The sensations are similar to those accompanying manual **Frequency** change.

Impedance is determined by the combined physical characteristics of the skin, defining its ability to absorb the **Energy** generated by the device.

Stimulus is a single two-phase output pulse.

CONTENTS

MARKS AND SYMBOLS ON THE DEVICE LABEL.....	4
DEFINITIONS.....	5
1 PURPOSE.....	7
2 SPECIFICATIONS.....	8
3 PACKAGE CONTENTS.....	11
4 SCENAR DEVICE OVERVIEW.....	12
4.1 SCENAR HOME.....	12
4.2 SCENAR SPORT.....	16
4.3 SCENAR BASIC.....	21
5 GETTING STARTED.....	23
5.1 SCENAR HOME.....	23
5.2 SCENAR SPORT.....	25
5.3 SCENAR BASIC.....	26
6 USING SCENAR DEVICE.....	27
6.1 SCENAR HOME.....	27
6.2 SCENAR SPORT.....	28
6.3 SCENAR BASIC.....	28
7 MAINTENANCE.....	29
8 TROUBLESHOOTING.....	30
9 WARRANTY.....	32
10 TRANSPORTATION AND STORAGE.....	33
ANNEX 1.....	34

1 PURPOSE

- **SCENAR Home** biofeedback transcutaneous electrostimulator with individual dosing of reflex zone stimulation;
- **SCENAR Sport** transcutaneous three-mode electrostimulator with individual dosing of reflex zone stimulation;
- **SCENAR Basic** transcutaneous dual-mode electrostimulator with individual dosing of reflex zone stimulation.

SCENAR Home, SCENAR Sport, SCENAR Basic transcutaneous electrostimulators (hereinafter called the SCENAR device or the device or SCENAR) are intended for general therapeutic non-invasive treatment of the human skin in order to remove pain of different etiology, alleviate diseases, and speed up the recovery process of the organs and systems in the course of combined therapy of different diseases.

The SCENAR device can be used:

- by home users and in medical and prophylactic institutions to remove or reduce pain syndromes of various genesis, swelling, to speed up the recovery process and prevent complications after traumas of any kind and also to restore dysfunctions of the body in various diseases;
- only in medical and prophylactic institutions – as a stand-alone treatment or alongside other therapies to remove postsurgical pain syndrome and acute pain (including renal colic).

The SCENAR device is intended for use over a temperature range of 10 °C to 35 °C, and relative humidity up to 80 % at 25 °C.

Potential risk from the device usage refers to Class IIa (2a) DIRECTIVE 93/42/EEC (GOST R 31508).

The device complies with the standards EN 60601-1 (GOST R 50267.0) and EN 60601-2-10 (GOST R 50267.10) for internally powered equipment, type BF, which classifies it as a safe device for personal use.

2 SPECIFICATIONS

2.1 Power supply: one 9 V alkaline battery.

2.2 Current consumption: max – 85 mA.

2.3 At a load (see Fig.1) SCENAR performs:

- generation of two-phase stimuli without a DC-component (see Fig.2) with a waveform depending on the skin impedance under the electrode (see Fig.3 through 5);
- control of the stimulus' 1st phase duration (see Fig.2) within (4 ± 2) to (500 ± 50) μsec , meanwhile the amplitude of the first pulse of the stimulus' 2nd phase at L1 load (see Fig.1) varies from $(1.7 \dots 2.8)$ V to $(100 \dots 150)$ V. Amplitude control step – max 1 V.

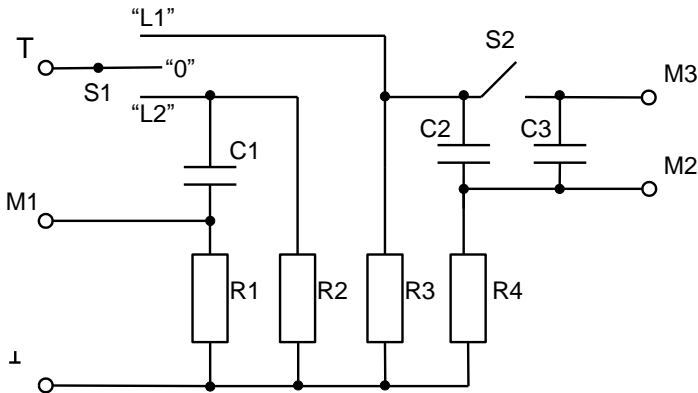

C1	K73-11-630 V-2200 pF $\pm 10 \%$
C2, C3	K73-11-250 V-0.033 μF $\pm 10 \%$
R1	1/4W 11 k Ω $\pm 5 \%$
R2, R3	1/4W 91 k Ω $\pm 5 \%$
R4	1/4W 560 Ω $\pm 5 \%$

M1...M3 are measuring points

Fig.1

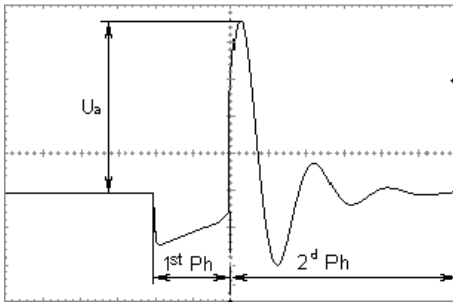

1st Ph – stimulus' 1st phase duration
 2^d Ph – stimulus' 2nd phase duration
 U_a – stimulus' 2nd phase 1st pulse amplitude

Fig.2

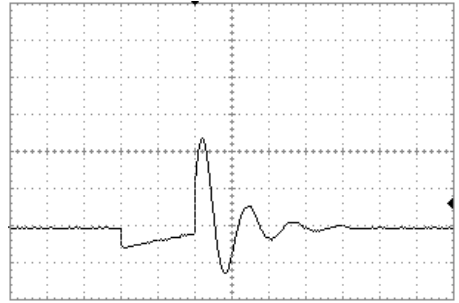

Load L1; S2 – 'Off',
 load capacity – 33 nF

Fig.3

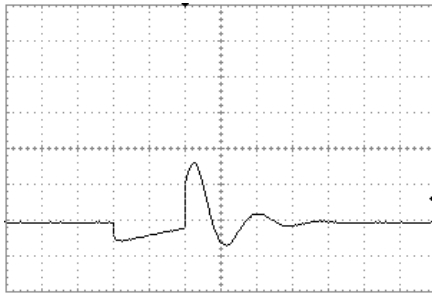

Load L1, S2 – 'On',
 load capacity – 66 nF

Fig.4

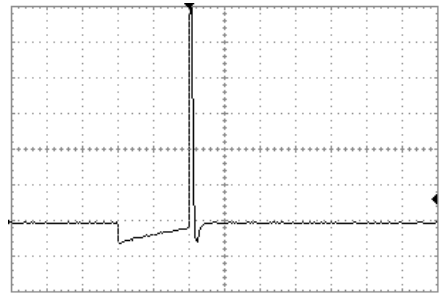

Load L2,
 load capacity – 2.2 nF

Fig.5

2.4 Fixed stimuli frequencies:

- SCENAR Home – 90 Hz ± 10 %;
- SCENAR Sport – 14, 60, 90, 340 Hz ± 10 %;
- SCENAR Basic – 60, 90 Hz ± 10 %.

2.5 Frequency modulation ('Fm') with the following parameters (only for SCENAR Home and SCENAR Sport):

- frequency range – (30 ± 3) Hz to (120 ± 12) Hz;
- cycle of modulation – (7 ± 2) sec.

2.6 Amplitude modulation ('Am', see Fig.6) with the following parameters:

- duration of stimuli bursts with set amplitude – (3.0 ± 0.5) sec;
- pause (stimuli bursts with minimum amplitude value) duration – (1.0 ± 0.3) sec.

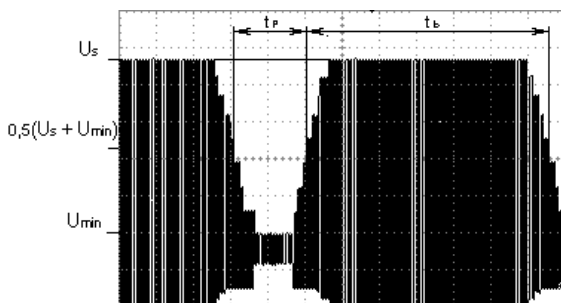

U_{\min} – minimum amplitude

U_s – set amplitude

t_p – pause duration

t_b – stimuli burst duration

Fig.6

2.7 Time of dosed stimulation with L1 load:

- SCENAR Home – 20 to 40 sec;
- SCENAR Sport – 30 to 60 sec;
- SCENAR Basic – 45 to 75 sec.

2.8 SCENAR device automatic turn-off time – (60 ± 20) sec.

2.9 SCENAR device weight: max – 0.2 kg.

2.10 Overall dimensions: max – 140 x 55 x 35 mm.

2.11 Average service life: min – 5 years.

3 PACKAGE CONTENTS

See Table 1 for SCENAR complete delivery set:

Table 1

Item	Quantity, units
SCENAR Home – a biofeedback transcutaneous electrostimulator with individual dosing of reflex zone stimulation	□
SCENAR Sport – a transcutaneous triple-mode electrostimulator with individual dosing of reflex zone stimulation	□
SCENAR Basic – a transcutaneous dual-mode electrostimulator with individual dosing of reflex zone stimulation	□
9 V PP3 type battery (6F22KG, 1604)	1
Case	1
Consumer packaging	1
Operating Manual	1
Instruction for Use	1
<p>Note:</p> <p>1) On the customer's request, SCENAR devices can be completed with the following add-on electrodes:</p> <ul style="list-style-type: none"> – Face electrode – Comb electrode – Point electrode – Special Snail electrode – Bent point electrode – Double facial Pawns electrode – Double cosmetic electrode – Double ophthalmic Goggles electrode – Double facial Stamps electrode – Single ophthalmic Monocle electrode – Special double Pencils electrode – Large comb electrode – Multi-purpose zonal electrode <p>2) Add-on electrodes listed in item 1) can be purchased on the customer's request at extra cost.</p>	

4 SCENAR DEVICE OVERVIEW

4.1 SCENAR HOME

Fig.7 shows the SCENAR Home device exterior.

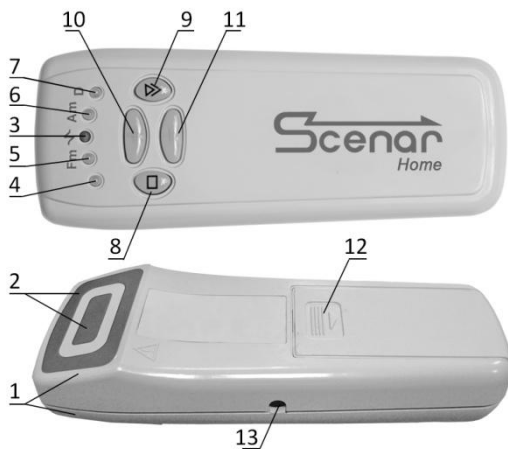

Fig.7

4.1.1 On the back side of the casing (1) there is a built-in electrode (2) and a battery cover (12).

4.1.2 On the front side of the casing there are the following visual indicators:

- 3 – ‘ \sim ’ LED – indicates the energy level (stimulus strength);
- 4 LED – the visual indicator of general purpose;
- 5 – ‘Fm’ LED – indicates the Frequency Modulation (‘Fm’) mode preselecting;
- 6 – ‘Am’ LED – indicates the Amplitude Modulation (‘Am’) mode preselecting;
- 7 – ‘D’ LED – indicates the Dosing mode preselecting.

The 4, ‘Fm’, ‘Am’ and ‘D’ LEDs are as well used:

- to indicate energy level (when adjusting the energy);
- (optional) to display the levels of initial reactions and the dose progress in the **Dose 1** mode;
- (optional) to display current reaction to the initial reaction ratio in the **Dose 2** mode.

4.1.3 On the front side of the casing there are following buttons:

- 8 – ‘□’ button – switches the SCENAR device **ON** and **OFF**;
- 9 – ‘ ∇ ’ button – preselects the desired stimulation mode;

- **10** – ‘+’ button – activates the preselected mode or increases the energy level (stimulus strength);
- **11** – ‘-’ button – deactivates the preselected mode or decreases the energy level (stimulus strength).

4.1.4 On the left side of the casing there is a jack (13) intended for connecting the add-on electrodes which can be supplied additionally upon request.



ATTENTION! Only the add-on electrodes produced by the SCENAR manufacturer can be used. Be careful: use only plug-compatible add-on electrodes. Using the incompatible or produced by the other manufacturer add-on electrodes may result in damaging the jack and making the warranty invalid!

4.1.5 To adjust the energy level (stimulus strength) either press the ‘+’ or ‘-’ button respectively step by step (1 step = 1 unit) or press and hold the button (speedy adjustment).

The energy level increase is accompanied by clicks at the adjustment rate, the increase of the ‘~’ LED brightness and the ‘Fm’, ‘Am’ and ‘D’ LEDs lighting up one after another:

- ‘4’ – from minimal energy to 25 %;
- ‘4’, ‘Fm’ – from 26 to 50 %;
- ‘4’, ‘Fm’, ‘Am’ – from 51 to 75 %;
- ‘4’, ‘Fm’, ‘Am’, ‘D’ – from 76 to 100 %;

A long beep indicates the upper energy level limit.

The energy level decrease is accompanied by clicks at the adjustment rate, the decrease of the ‘~’ LED brightness and the ‘D’, ‘Am’ and ‘Fm’ LEDs going out one after another, as shown above. A long beep indicates the lower energy level limit.

4.1.6 To set the Dosing mode, press the ‘☑’ button (sequence of single taps) until the ‘D’ LED lights up. While the ‘D’ LED is glowing, press the ‘+’ button to switch the mode on, and the ‘-’ button - to switch it off. The mode switching on is accompanied by an ascending two-tone beep, the switching off – with a descending two-tone beep. In Dosing mode when the electrode is placed on the skin, a short high-pitch beep sounds and the ‘D’ LED lights up. In 1-3 sec a short low-pitch beep sounds and the ‘D’ LED switches out.

(Optional) To select the Dosing mode, press the ‘☑’ button (sequence of single taps) until the ‘D’ LED starts blinking. While the ‘D’ LED is blinking, the ‘D1’ mode can be selected by pressing the ‘+’ button (sequence of single taps). The activation of the ‘D1’ mode is indicated by a short single beep and long flashes of the ‘D’ LED during 2 seconds.

(Optional) Also while the ‘D’ LED is blinking, the ‘D2’ mode can be selected by pressing the ‘+’ button (sequence of single taps). The activation of the ‘D2’ mode is indicated by two short beeps and short intermittent flashes of the ‘D’ LED during 2 seconds.

(Optional) To switch the Dosing mode off, press the ‘-’ button while the ‘D’ LED is blinking; the mode switching off is indicated by a long beeping sound and short flashes of the ‘D’ LED during 2 seconds.

(Optional) In the ‘D1’ mode when the electrode is placed on the skin, a short high-pitch beep sounds. In 1-3 sec – a short low-pitch beep. All four LEDs indicate a level of initial reaction during 1 second after the second beep:

Reaction level			Indication
	Reaction	< 18	All LEDs are switched off
18 <=	Reaction	< 25	LED ‘D’ lights up
25 <=	Reaction	< 40	LEDs ‘D’ and ‘Am’ light up
40 <=	Reaction	< 60	LEDs ‘D’, ‘Am’ and ‘Fm’ light up
60 <=	Reaction		LEDs ‘D’, ‘Am’, ‘Fm’ and ‘4’ light up

While delivering the dose, the ‘D’, ‘Am’, ‘Fm’ and ‘4’ LEDs light up sequentially (by one or several together), single beeps may sound – depending on the dose delivery rate. The greater the number of glowing LEDs, the less time is left to reach the dose; when the dose is reached, all the four LEDs flash on shortly and an intermittent beep sounds. The LEDs light-up rate and the number of intermediate beeps can vary on different skin areas.

When the dose is reached, all the LEDs flash on shortly and a two-tone beep sounds.

(Optional) The ‘D2’ mode is intended for searching skin areas with maximal reaction in a labile mode. If the current reaction exceeds the previous maximum, this is indicated by a **clicking sound**. The current reaction to the initial reaction ratio is indicated by LEDs flashing on:

The current to the initial reaction ratio			Indication
	Ratio	< ½	All LEDs are switched off
½ <=	Ratio	< 1	LED ‘D’ lights up
1 <=	Ratio	< 1½	LEDs ‘D’ and ‘Am’ light up
1½ <=	Ratio	< 2	LEDs ‘D’, ‘Am’ and ‘Fm’ light up and the device emits a single beep every second
2 <=	Ratio		LEDs ‘D’, ‘Am’, ‘Fm’ and ‘4’ light up and the device emits double beep every second



ATTENTION! *In fact there is a double indication: a relative value of current reaction to initial one – by **LEDs** and sounds, and an absolute maximum of reaction – by **clicks**.*

4.1.7 To set the AM mode, press the ‘’ button (sequence of single taps) until the ‘**Am**’ LED starts blinking. While the ‘**Am**’ LED is blinking, press the ‘**+**’ button to switch the mode on, and press the ‘**–**’ button to switch the mode off. The mode switching on is accompanied by an ascending two-tone beep, the switching off – by a descending two-tone beep.

In the Amplitude modulation mode the stimulation is intermittent: 3 sec – stimulation, 1 sec – pause. The ‘’ LED brightness is changing.

4.1.8 To set the FM mode press the ‘’ button (sequence of single taps) until the ‘**Fm**’ LED starts blinking. While the ‘**Fm**’ LED is blinking, press the ‘**+**’ button to switch the mode on, and press the ‘**–**’ button to switch the mode off. The mode switching on is accompanied by an ascending two-tone beep, the mode switching off – by a descending two-tone beep.

In the Frequency modulation mode the stimulation frequency is continuously changing from 30 to 120 Hz and back. The ‘’ LED brightness is changing depending on the pulse frequency.

4.1.9 Some modes may be used together: ‘**D+Am**’, ‘**D+Fm**’, ‘**D+Am+Fm**’, ‘**Am+Fm**’. For this purpose, switch on the required modes sequentially.

(Optional) For user’s convenience SCENAR has two pre-installed modes (**Presets**).

To enter the **preselection mode** press the ‘’ button (sequence of single taps) until the ‘rolling light’ (sequential short flashes of the LEDs during 2 seconds). In this mode you can select one of two presets by pressing the ‘**+**’ button. Selected and set mode is indicated by LEDs and sound:

- **Preset 1** (single beep, ‘**Am**’ and ‘**Fm**’ LEDs go ON): frequency modulation and amplitude modulation are switched ON.
- **Preset 2** (double beep, ‘**D**’ and ‘**F**’ LEDs go ON): the number of pulses in a batch and the gap between the pulses are controlled automatically at the 90 Hz frequency.

While any **Preset** is ON, the switching to another mode by pressing the ‘’ button will be locked and LEDs will be glowing according to the active **Preset**. Turn the **Preset** OFF to return to regular operation mode.

To turn the **Preset** OFF press the ‘**–**’ button, while the LEDs are glowing according to the active **Preset**. When the **Preset** is turned OFF, the energy level will be saved, all other parameters will be set to default (‘**Fm**’, ‘**Am**’ and ‘**D**’ are turned OFF, the frequency is 90 Hz).

(Optional) For user's convenience SCENAR provides the quick access to the **Preset 2**. For this purpose press the '+' and '-' buttons simultaneously.

4.1.10 Enabling/disabling sounds:

- to enable sounds, press the '🔊' and '+' buttons simultaneously (the SCENAR device emits a beep);
- to disable sounds, press the '🔇' and '-' buttons (no sounds).

4.1.11 (Optional) To lock/unlock a keyboard, press and hold the '□' and '-' buttons (for about 2 sec) until the SCENAR device emits a two-tone descending/ascending beep.

If the SCENAR device switches off automatically, the keyboard will be unlocked when the SCENAR device is switched on next time.

4.1.12 To switch the SCENAR device on with the energy level set before it was switched off press and hold the '□' and '+' buttons (for about 2 sec), until the SCENAR device emits an intermittent high-pitch beep.



ATTENTION! When the SCENAR device is switched on with the energy level set before it was switched off, the sound indication is different from default.

4.2 SCENAR SPORT

Fig.8 shows the SCENAR device exterior.

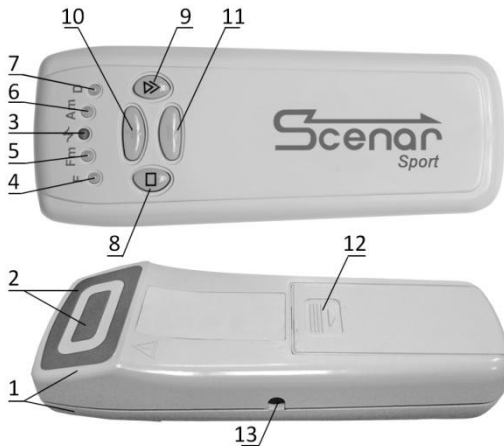

Fig.8

4.2.1 On the back side of the casing (1) there is a built-in electrode (2) and a battery cover (12).

4.2.2 On the front side of the casing there are following indicators:

- **3** – ‘**↖**’ **LED** – indicates the energy level (stimulus strength);
- **4** – ‘**F**’ **LED** – indicates the stimulation frequency preselecting;
- **5** – ‘**Fm**’ **LED** – indicates the **F**requency **M**odulation (‘**Fm**’) mode preselecting;
- **6** – ‘**Am**’ **LED** – indicates the **A**mplitude **M**odulation (‘**Am**’) mode preselecting;
- **7** – ‘**D**’ **LED** – indicates the **D**osing mode preselecting.

The ‘**F**’, ‘**Fm**’, ‘**Am**’ and ‘**D**’ LEDs are as well used:

- to indicate stimulation energy level (when adjusting the energy);
- (optional) to display the levels of initial reactions and the dose progress in the **Dose 1** mode;
- (optional) to display current reaction to the initial reaction ratio in the **Dose 2** mode.

4.2.3 On the front side of the casing there are following buttons:

- **8** – ‘**□**’ button – switches the **SCENAR** device **ON** and **OFF**;
- **9** – ‘**☑**’ button – preselects the **desired** stimulation mode;
- **10** – ‘**+**’ button – activates the preselected mode or increases the energy level (stimulus strength);
- **11** – ‘**-**’ button – deactivates the preselected mode or decreases the energy level (stimulus strength).

4.2.4 On the left side of the casing there is a jack (13) intended for connecting the add-on electrodes which can be supplied additionally upon request.



ATTENTION! Only the add-on electrodes produced by the **SCENAR** manufacturer can be used. Be careful: use only plug-compatible add-on electrodes. Using the incompatible or produced by the other manufacturer add-on electrodes may result in damaging the jack and making the warranty invalid!

4.2.5 To increase or decrease the energy level (stimulus strength) either press the ‘**+**’ or ‘**-**’ button respectively step by step (1 step = 1 unit) or press and hold the button (speedy adjustment).

The energy level increase is accompanied by clicks at the adjustment rate, the increase of the ‘**↖**’ LED brightness and the ‘**Fm**’, ‘**Am**’ and ‘**D**’ LEDs lighting up one after another:

- ‘**F**’ – from minimal energy to 25 %;
- ‘**F**’, ‘**Fm**’ – from 26 to 50 %;
- ‘**F**’, ‘**Fm**’, ‘**Am**’ – from 51 to 75 %;
- ‘**F**’, ‘**Fm**’, ‘**Am**’, ‘**D**’ – from 76 to 100 %;

A long beep indicates the upper energy level limit.

The energy level decrease is accompanied by clicks at the adjustment rate, the decrease of the ‘ \wedge ’ LED brightness and the ‘**D**’, ‘**Am**’ and ‘**Fm**’ LEDs going out one after another, as shown above. A long beep indicates the lower energy level limit.

4.2.6 To set the Dosing mode, press the ‘ \heartsuit ’ button (sequence of single taps) until the ‘**D**’ LED lights up. While the ‘**D**’ LED is glowing, press the ‘**+**’ button to switch the mode on, and the ‘**-**’ button – to switch it off. The mode switching on is accompanied by an ascending two-tone beep, the switching off – with a descending two-tone beep. In Dosing mode when the electrode is placed on the skin, a short high-pitch beep sounds and the ‘**D**’ LED lights up. In 1-3 sec a short low-pitch beep sounds and the ‘**D**’ LED switches out.

(Optional) To select the Dosing mode, press the ‘ \heartsuit ’ button (sequence of single taps) until the ‘**D**’ LED starts blinking. While the ‘**D**’ LED is blinking, the ‘**D1**’ mode can be selected by pressing the ‘**+**’ button (sequence of single taps). The activation of the ‘**D1**’ mode is indicated by a short single beep and long flashes of the ‘**D**’ LED during 2 seconds.

(Optional) Also while the ‘**D**’ LED is blinking, the ‘**D2**’ mode can be selected by pressing the ‘**+**’ button (sequence of single taps). The activation of the ‘**D2**’ mode is indicated by two short beeps and short intermittent flashes of the ‘**D**’ LED during 2 seconds.

(Optional) To switch the Dosing mode off, press the ‘**-**’ button while the ‘**D**’ LED is blinking; the mode switching off is indicated by a long beeping sound and short flashes of the ‘**D**’ LED during 2 seconds.

(Optional) In the ‘**D1**’ mode when the electrode is placed on the skin, a short high-pitch beep sounds. In 1-3 sec – a short low-pitch beep. All four LEDs indicate a level of initial reaction during 1 second after the second beep:

Reaction level		Indication
	Reaction < 18	All LEDs are switched off
18 <=	Reaction < 25	LED ‘ D ’ lights up
25 <=	Reaction < 40	LEDs ‘ D ’ and ‘ Am ’ light up
40 <=	Reaction < 60	LEDs ‘ D ’, ‘ Am ’ and ‘ Fm ’ light up
60 <=	Reaction	LEDs ‘ D ’, ‘ Am ’, ‘ Fm ’ and ‘ F ’ light up

While delivering the dose, the ‘**D**’, ‘**Am**’, ‘**Fm**’ and ‘**F**’ LEDs light up sequentially (by one or several together), single beeps may sound – depending on the dose delivery rate. The greater the number of glowing LEDs, the less time is left to reach the dose; when the dose is reached, all the four LEDs flash on shortly and an intermittent beep sounds. The LEDs light-up rate and the number of intermediate beeps can vary on different skin areas.

When the dose is reached, all the LEDs flash on shortly and a two-tone beep sounds.

(Optional) The ‘D2’ mode is intended for searching skin areas with maximal reaction in a labile mode. If the current reaction exceeds the previous maximum, this is indicated by a **clicking sound**. The current reaction to the initial reaction ratio is indicated by LEDs flashing on:

The current to the initial reaction ratio	Indication
Ratio < ½	All LEDs are switched off
½ ≤ Ratio < 1	LED ‘D’ lights up
1 ≤ Ratio < 1½	LEDs ‘D’ and ‘Am’ light up
1½ ≤ Ratio < 2	LEDs ‘D’, ‘Am’ and ‘Fm’ light up and the device emits a single beep every second
2 ≤ Ratio	LEDs ‘D’, ‘Am’, ‘Fm’ and ‘F’ light up and the device emits double beep every second



ATTENTION! In fact there is a double indication: a relative value of current reaction to initial one – by **LEDs** and sounds, and an absolute maximum of reaction – by **clicks**.

4.2.7 To set the AM mode, press the ‘✔’ button (sequence of single taps) until the ‘Am’ LED starts blinking. While the ‘Am’ LED is blinking, press the ‘+’ button to switch the mode on, and press the ‘-’ button to switch the mode off. The mode switching on is accompanied by an ascending two-tone beep, the switching off – by a descending two-tone beep.

In the Amplitude modulation mode the stimulation is intermittent: 3 sec – stimulation, 1 sec – pause. The ‘-’ LED brightness is changing.

4.2.8 To set the FM mode press the ‘✔’ button (sequence of single taps) until the ‘Fm’ LED starts blinking. While the ‘Fm’ LED is blinking, press the ‘+’ button to switch the mode on, and press the ‘-’ button to switch the mode off. The mode switching on is accompanied by an ascending two-tone beep, the mode switching off – by a descending two-tone beep.

In the Frequency modulation mode the stimulation frequency is continuously changing from 30 to 120 Hz and back. The ‘-’ LED brightness is changing depending on the pulse frequency.

4.2.9 To select one of four stimulation frequencies (14, 60, 90 or 340 Hz), press the ‘✔’ button (sequence of single taps) until the ‘F’ LED starts blinking. To select a frequency press the ‘+’ or ‘-’ button (sequence of single taps) while the ‘F’ LED is blinking. The frequency selection is accompanied by short beeps:

- 14 Hz – one beep;
- 60 Hz – two beeps;

- 90 Hz – three beeps;
- 340 Hz – four beeps.

Once a new frequency is set, the ‘**✓**’ LED brightness changes.

When the ‘**Fm**’ mode is on, the frequency set in the ‘**F**’ mode is disregarded and the frequency selection is blocked. When the ‘**Fm**’ mode is switched off, the previously used frequency is set.

4.2.10 Some modes may be used together: ‘**D+Am**’ (at any frequency), ‘**D+Fm**’, ‘**D+Am+Fm**’, ‘**Am+Fm**’. For this purpose, switch on the required modes sequentially.

(Optional) For user’s convenience SCENAR has two pre-installed modes (**Presets**).

To enter the **preselection mode** press the ‘**✓**’ button (sequence of single taps) until the ‘rolling light’ (sequential short flashes of the LEDs during 2 seconds). In this mode you can select one of two presets by pressing the ‘**+**’ button. Selected and set mode is indicated by LEDs and sound:

- **Preset 1** (single beep, ‘**Am**’ and ‘**Fm**’ LEDs go ON): frequency modulation and amplitude modulation are switched ON.
- **Preset 2** (double beep, ‘**D**’ and ‘**F**’ LEDs go ON): the number of pulses in a batch and the gap between the pulses are controlled automatically at the 90 Hz frequency.

While any **Preset** is ON, the switching to another mode by pressing the ‘**✓**’ button will be locked and LEDs will be glowing according to the active **Preset**. Turn the **Preset** OFF to return to regular operation mode.

To turn the **Preset** OFF press the ‘**—**’ button, while the LEDs are glowing according to the active **Preset**. When the **Preset** is turned OFF, the energy level will be saved, all other parameters will be set to default (‘**Fm**’, ‘**Am**’ and ‘**D**’ are turned OFF, the frequency is 60 Hz).

(Optional) For user’s convenience SCENAR provides the quick access to the **Preset 2**. For this purpose press the ‘**+**’ and ‘**—**’ buttons simultaneously.

4.2.11 Enabling/disabling sounds:

- to enable sounds, press the ‘**✓**’ and ‘**+**’ buttons simultaneously (the SCENAR device emits a beep);
- to disable sounds, press the ‘**✓**’ and ‘**—**’ buttons simultaneously (no sounds).

4.2.12 (Optional) To lock/unlock a keyboard press and hold the ‘**□**’ and ‘**—**’ buttons (for about 2 sec) until the SCENAR device emits a two-tone descending/ascending beep.

If the SCENAR device switches off automatically, the keyboard will be unlocked when the SCENAR device is switched on next time.

4.2.13 To switch the SCENAR device on with the energy level set before it was switched off press and hold the ‘□’ and ‘+’ buttons (for about 2 sec), until the SCENAR device emits an intermittent high-pitch beep.



ATTENTION! When the SCENAR device is switched on with the energy level set before it was switched off, the sound indication is different from default.

4.3 SCENAR BASIC

Fig.9 shows the SCENAR Basic device exterior.

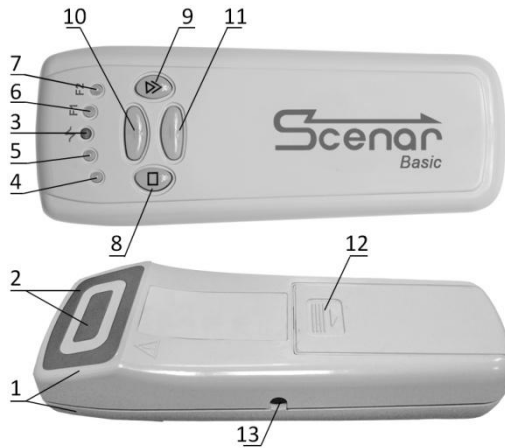

Fig.9

4.3.1 On the back side of the casing (1) there is a built-in electrode (2) and a battery cover (12).

4.3.2 On the upper side of the casing there are following indicators:

- **3 – ‘-∨’ LED** – indicates the energy level (stimulus strength);
- **4, 5 LEDs** – the visual indicators of general purpose;
- **6 – ‘F1’ LED** indicates the Dosing mode with the constant frequency of 60 Hz and ‘Am’ (‘F1’ mode);
- **7 – ‘F2’ LED** – indicates the mode with the constant frequency of 90 Hz while the number of pulses in a batch and the gap between the pulses are controlled automatically (‘F2’ mode).



The **4, 5, ‘F1’** and **‘F2’** LEDs are as well used:

- to indicate stimulation energy level (when adjusting the energy):
 - ◆ **4** – from minimal energy to 25 %;
 - ◆ **4, 5** – from 26 to 50 %;
 - ◆ **4, 5, ‘F1’** – from 51 to 75 %;

◆ **4, 5, 'F1', 'F2'** – from 76 to 100 %;

- to display current reaction to the initial reaction ratio in the **'F2'** (screening) mode.

4.3.3 On the front side of the casing there are following buttons:

- **8** –  button – switches the SCENAR device **ON** and **OFF**;
- **9** –  button – switches between the stimulation modes;
- **10** – **+** button – increases the energy level;
- **11** – **-** button – decreases the energy level.

4.3.4 On the left side of the casing there is a jack (13) intended for connecting the add-on electrodes which can be supplied additionally upon request.



ATTENTION! Only the add-on electrodes produced by the SCENAR manufacturer can be used. Be careful: use only plug-compatible add-on electrodes. Using the incompatible or produced by the other manufacturer add-on electrodes may result in damaging the jack and making the warranty invalid!

4.3.5 To increase or decrease the energy level either press the **+** or **-** button respectively step by step (1 step = 1 unit) or press and hold the button (speedy adjustment).

The energy level increase is accompanied by clicks at the adjustment rate, the increase of the **'A'** LED brightness and the **5, 'F1'** and **'F2'** LEDs lighting up one after another. A long beep indicates the upper energy level limit.

The energy level decrease is accompanied by clicks at the adjustment rate, the decrease of the **'A'** LED brightness and the **'F2', 'F1'** and **5** LEDs going out one after another. A long beep indicates the lower energy level limit.

4.3.6 Press the  button to select the **'F1'** mode (stimulation in Dosing mode with the constant frequency of 60 Hz and **'Am'**) and the **'F2'** mode (stimulation with the constant frequency of 90 Hz while the number of pulses in a batch and the gap between the pulses are controlled automatically). This is accompanied by the **'F1'** or **'F2'** LED (respectively) flashing on for 2 seconds.

In the **'F1'** mode, when the electrode is placed on the skin, a short high-pitch beep sounds. In 1-3 sec – a short low-pitch beep sounds and the **'F2'** LED flashes on shortly. While delivering the dose, the **'F2', 'F1', 5, 4** LEDs light up sequentially (by one or several together), single beeps may sound – depending on the dose delivery rate.

When the dose is reached, all the LEDs flash on shortly and a two-tone beep sounds.

The LEDs light-up rate and the number of intermediate beeps can vary on different skin areas.

(Optional) In the ‘F1’ mode when the electrode is placed on the skin, a short high-pitch beep sounds. In 1-3 sec – a short low-pitch beep. All four LEDs indicate a level of initial reaction during 1 second after the second beep:

Reaction level	Indication
Reaction < 18	All LEDs are switched off
18 <= Reaction < 25	LED ‘F1’ lights up
25 <= Reaction < 40	LEDs ‘F1’ and ‘F2’ light up
40 <= Reaction < 60	LEDs ‘F1’, ‘F2’ and 5 light up
60 <= Reaction	LEDs ‘F1’, ‘F2’, 5 and 4 light up



ATTENTION! In fact there is a double indication: a relative value of current reaction to initial one – by **LEDs** and **sounds**, and an absolute maximum of reaction – by **clicks**.

4.3.7 Enabling/disabling sounds:

- to enable sounds, press the ‘✔’ and ‘+’ buttons simultaneously (the SCENAR device emits a beep);
- to disable sounds, press the ‘✔’ and ‘-’ buttons simultaneously (no sounds).

4.3.8 (Optional) To lock/unlock a keyboard press and hold the ‘□’ and ‘-’ buttons (for about 2 sec) until the SCENAR device emits a two-tone descending/ascending beep.

If the SCENAR device switches off automatically, the keyboard will be unlocked when the SCENAR device is switched on next time.

4.3.9 To switch the SCENAR device on with the energy level set before it was switched off press and hold the ‘□’ and ‘+’ buttons (for about 2 sec) until the SCENAR device emits an intermittent high-pitch beep.



ATTENTION! When the SCENAR device is switched on with the energy level set before it was switched off, the sound indication is different from default.

5 GETTING STARTED



ATTENTION! Remove the protective film from the built-in electrode before using the SCENAR device.

5.1 SCENAR HOME

5.1.1 Remove the battery cover and insert the battery observing polarity.



If the battery is installed correctly a beep sounds and the ‘-V’ LED lights up. Otherwise reset the SCENAR device (refer to item 5.1.2).



ATTENTION! *DO NOT use any power adapters to power the SCENAR device from the line supply.*

5.1.2 The SCENAR device can be reset in case of failure or when it is required to rapidly return to the **default settings**:

- stimulus energy – **minimal**;
- **Fm** mode – **OFF**;
- **Am** mode – **OFF**;
- Dosing mode – **OFF**;
- stimuli frequency – **90 Hz**;
- sound indication – **ON**;
- keyboard – **unlocked**.

To reset to the default settings, press and hold the ‘’ and ‘’ buttons simultaneously (for about 2 sec) until the intermittent audio signal sounds. The reset to the default settings occurs irrespective of whether the SCENAR device is turned on or off.

5.1.3 Repeatedly press the ‘’ button to make sure that the ‘**D**’, ‘**Am**’, ‘**Fm**’ and ‘**4**’ LEDs light up one after another, then the ‘rolling light’, then ‘**D**’ again and so on. The selected LED goes out after 2 seconds if no button has been pressed.

5.1.4 Use the ‘**+**’ or ‘**-**’ button to adjust the stimuli energy. This is accompanied by the LEDs flashing on indicating the energy level:

- **4** – from minimal energy to 25 %;
- **4**, ‘**Fm**’ – from 26 to 50 %;
- **4**, ‘**Fm**’, ‘**Am**’ – from 51 to 75 %;
- **4**, ‘**Fm**’, ‘**Am**’, ‘**D**’ – from 76 to 100 %.

When the mode is preselected (the appropriate LED is glowing), press the ‘**+**’ or ‘**-**’ button to switch the mode on or off respectively.

5.1.5 To switch the SCENAR device off press and hold the ‘’ button (for about 2 sec) until the intermittent audio signal sounds.

5.1.6 The supply voltage is monitored when the SCENAR device is on: if it is lower than (8.1 ± 0.1) V, the short audio signals sound repeatedly (approximately twice a second), indicating that the battery should be replaced. Otherwise, the manufacturer shall bear no liability for incompliance of the SCENAR device performance with the specifications stated in this Operating Manual.



ATTENTION! *The low voltage sound indication is deactivated when changing the settings or if there is a skin contact.*

5.1.7 If the SCENAR device operates as described above, it is ready for use. Otherwise, refer to Chapter 8.

5.1.8 Cleaning & Disinfecting: Wipe the outer surface of the SCENAR device with a cotton swab dampened with 3 % hydrogen peroxide solution with the addition of 0.5 % solution of an approved cleaning liquid. Allow to dry up thoroughly before use.

5.2 SCENAR SPORT

5.2.1 Remove the battery cover and insert the battery observing polarity.

If the battery is installed correctly, a beep sounds and the ‘ ∇ ’ LED lights up. Otherwise reset the SCENAR device (refer to item 5.2.2).



ATTENTION! DO NOT use any power adapters to power the SCENAR device from the line supply!

5.2.2 The SCENAR device can be reset in case of failure or when it is required to rapidly return to the **default settings**:

- stimulus energy – **minimal**;
- **Fm** mode – **OFF**;
- **Am** mode – **OFF**;
- Dosing mode – **OFF**;
- stimuli frequency – **60 Hz**;
- sound indication – **ON**;
- keyboard – **unlocked**.

To reset to the default settings, press and hold the ‘ ∇ ’ and ‘ \square ’ buttons simultaneously (for about 2 sec) until the intermittent audio signal sounds. The reset to the default settings occurs irrespective of whether the SCENAR device is turned on or off.

5.2.3 Repeatedly press the ‘ ∇ ’ button to make sure that the ‘**D**’, ‘**Am**’, ‘**Fm**’ and ‘**F**’ LEDs light up one after another, then the ‘rolling light’, then ‘**D**’ again and so on. The selected LED goes out after 2 seconds if no button has been pressed.

5.2.4 Use the ‘**+**’ or ‘**-**’ buttons to adjust the stimuli energy. This is accompanied by the LEDs flashing on indicating the energy level:

- ‘**F**’ – from minimal energy to 25 %;
- ‘**F**’, ‘**Fm**’ – from 26 to 50 %;
- ‘**F**’, ‘**Fm**’, ‘**Am**’ – from 51 to 75 %;
- ‘**F**’, ‘**Fm**’, ‘**Am**’, ‘**D**’ – from 76 to 100 %.

When the mode is preselected (the appropriate LED is glowing), press the ‘**+**’ or ‘**-**’ button to switch the mode on or off respectively.

5.2.5 To switch the SCENAR device off press and hold the ‘ \square ’ button (for about 2 sec) until the intermittent audio signal sounds.

5.2.6 The supply voltage is monitored when the SCENAR device is on: if it is lower than (8.1 ± 0.1) V, the short audio signals sound repeated-

ly (approximately twice a second), indicating that the battery should be replaced (refer to item 7.2). Otherwise, the manufacturer shall bear no liability for incompliance of the SCENAR device performance with the specifications stated in this Operating Manual.



ATTENTION! *The low voltage sound indication is deactivated when changing the settings or if there is a skin contact.*

5.2.7 If the SCENAR device operates as described above, it is ready for use. Otherwise, refer to Chapter 8.

5.2.8 Cleaning & Disinfecting: Wipe the outer surface of the SCENAR device with a cotton swab dampened with 3 % hydrogen peroxide solution with the addition of 0.5 % solution of an approved cleaning liquid. Allow to dry up thoroughly before use.

5.3 SCENAR BASIC

5.3.1 Remove the battery cover and insert the battery observing polarity.

If the battery is installed correctly, a beep sounds and the ‘ ∇ ’ LED lights up. Otherwise reset the SCENAR device (refer to item 5.3.2).



ATTENTION! DO NOT use any power adapters to power the SCENAR device from the line supply.

5.3.2 The SCENAR device can be reset in case of failure or when it is required to rapidly choose the default settings:

- stimulus energy – **minimal**;
- ‘**F1**’ mode – **ON**;
- sound indication – **ON**;
- keyboard – **unlocked**.

To reset to the default settings, press and hold the ‘ ∇ ’ and ‘ \square ’ buttons simultaneously (for about 2 sec) until the intermittent audio signal sounds. The reset to the default settings occurs irrespective of whether the SCENAR device is turned on or off.

5.3.3 Repeatedly press the ‘ ∇ ’ button to make sure that the ‘**F1**’ and ‘**F2**’ LEDs light up one after another. The selected LED goes out after 2 seconds if no button has been pressed.

5.3.4 Use the ‘+’ or ‘-’ buttons to adjust the stimuli energy. This is accompanied by the LEDs flashing on indicating the energy level:

- **4** – from minimal energy to 25 %;
- **4, 5** – from 26 to 50 %;
- **4, 5, ‘F1’** – from 51 to 75 %;
- **4, 5, ‘F1’, ‘F2’** – from 76 to 100 %.

5.3.5 To switch the SCENAR device off press and hold the ‘□’ button (for about 2 sec) until the intermittent audio signal sounds.

5.3.6 The supply voltage is monitored when the SCENAR device is on: if it is lower than (8.1 ± 0.1) V, the short audio signals sound repeatedly (approximately twice a second), indicating that the battery should be replaced (refer to item 7.2). Otherwise, the manufacturer shall bear no liability for incompliance of the SCENAR device performance with the specifications stated in this Operating Manual.



ATTENTION! *The low voltage sound indication is deactivated when changing the settings or if there is a skin contact.*

5.3.7 If the SCENAR device operates as described above, it is ready for use. Otherwise, refer to Chapter 8.

5.3.8 Cleaning & Disinfecting: Wipe the outer surface of the SCENAR device with a cotton swab dampened with 3 % hydrogen peroxide solution with the addition of 0.5 % solution of an approved cleaning liquid. Allow to dry up thoroughly before use.

6 USING SCENAR DEVICE

6.1 SCENAR HOME

6.1.1 The Instruction for Use is the main document to be consulted with when delivering treatment with the SCENAR device.

6.1.2 To switch the SCENAR device on press and hold the ‘□’ button (for about 2 sec) until the single beep sounds and the ‘-▲-’ LED lights up.



ATTENTION! *All set stimulation modes (except for energy) are retained after the SCENAR is switched off.*

Reset the SCENAR device to the default settings if necessary (when you start treating a new patient) (item 5.1.2).

6.1.3 Place the electrode on the patient's skin. Wait for several seconds to make sure a patient does not have unpleasant sensations. Press and hold the ‘+’ button until the first pricking sensation, vibration or formication at the comfortable level.



ATTENTION! *To avoid uncomfortable and painful sensations of a patient, it is recommended to set the energy to minimum (by pressing and holding the ‘-’ button until the intermittent audio signal sounds) before the start of procedure or when going to treat the most sensitive skin areas.*



ATTENTION! *The SCENAR device switches itself off after 60 seconds if no button has been pressed and there is no skin contact.*

6.1.4 When the treatment is over, it is recommended to reset to default settings (refer to item 5.1.2). Switch the SCENAR device off (refer to item 5.1.5).

6.2 SCENAR SPORT

6.2.1 The Instruction for Use is the main document to be consulted with when delivering treatment with the SCENAR device.

6.2.2 To switch the SCENAR device on press and hold the ‘□’ button (for about 2 sec) until the single beep sounds and the ‘-v’ LED lights up.



ATTENTION! *All set stimulation modes (except for energy) are retained after the SCENAR is switched off.*

Reset the SCENAR device to the default settings if necessary (when you start treating a new patient) (item 5.2.2).

6.2.3 Place the electrode on the patient's skin. Wait for several seconds to make sure a patient does not have unpleasant sensations. Press and hold the ‘+’ button until the first pricking sensation, vibration or formication at the comfortable level.



ATTENTION! *To avoid uncomfortable and painful sensations of a patient, it is recommended to set the energy to minimum (by pressing and holding the ‘—’ button until the intermittent audio signal sounds) before the start of procedure or when going to treat the most sensitive skin areas.*



ATTENTION! *The SCENAR device switches itself off after 60 seconds if no button has been pressed and there is no skin contact.*

6.2.4 When the treatment is over, it is recommended to reset to default settings (refer to item 5.2.2). Switch the SCENAR device off (refer to item 5.2.5).

6.3 SCENAR BASIC

6.3.1 The Instruction for Use is the main document to be consulted with when delivering treatment with the SCENAR device.

6.3.2 To switch the SCENAR device on press and hold the ‘□’ button (for about 2 sec) until the single beep sounds and the ‘-v’ LED lights up.



ATTENTION! *Set stimulation mode is retained after the SCENAR is switched off, while the energy level is set to minimum.*

Reset the SCENAR device to the default settings if necessary (when

you start treating a new patient) (item 5.3.2).

6.3.3 Place the electrode on the patient's skin. Wait for several seconds to make sure a patient does not have unpleasant sensations. Press and hold the ‘+’ button until the first pricking sensation, vibration or formication at the comfortable level.



ATTENTION! To avoid uncomfortable and painful sensations of a patient, it is recommended to set the energy to minimum (by pressing and holding the ‘-’ button until the intermittent audio signal sounds) before the start of procedure or when going to treat the most sensitive skin areas.

6.3.4 When the treatment is over, it is recommended to reset to default settings (refer to item 5.3.2). Switch the SCENAR device off (refer to item 5.3.5).

7 MAINTENANCE

7.1 The SCENAR device shall be repaired only by the manufacturer.

7.2 In case the low battery level is indicated (short beeps twice a sec), open the battery compartment cover and replace the battery. It is recommended to reset the SCENAR device to the default settings in accordance with:

- item 5.1.2 for SCENAR Home,
- item 5.2.2 for SCENAR Sport,
- item 5.3.2 for SCENAR Basic.

8 TROUBLESHOOTING

8.1 The possible faults with the SCENAR device and troubleshooting methods are given in Table 2.

Table 2

Fault	Possible cause	Suggested solution
The SCENAR device does not operate in accordance with item 5.1.3 (for SCENAR Home), 5.2.3 (for SCENAR Sport) 5.3.3 (for SCENAR Basic). Or some adjustments fail.	Processor mal-function.	Reset the SCENAR device to the default settings in accordance with: item 5.1.2 for SCENAR Home, item 5.2.2 for SCENAR Sport, item 5.3.2 for SCENAR Basic. If the problem persists, contact the manufacturer.
The SCENAR device emits short beeps twice a sec when there is no skin contact.	Low battery.	Replace the battery. If the problem persists after the battery is replaced, contact the manufacturer.
The SCENAR device fails to switch ON.	The battery is discharged.	Replace the battery.
The SCENAR device does not emit any sounds.	The sound is switched OFF.	Reset the SCENAR device to the default settings in accordance with: Item 5.1.2 for SCENAR Home, item 5.2.2 for SCENAR Sport, item 5.3.2 for SCENAR Basic. If the problem persists, contact the manufacturer.
The SCENAR device operates but there is no energy on the built-in electrode.	The protective film is not removed from the built-in electrode.	Remove the protective film from the built-in electrode.

Continue table 2

Fault	Possible cause	Suggested solution
The SCENAR device operates but there is no energy on the built-in electrode.	The energy level is too low.	Increase the energy level until comfortable sensations appear.
There is no energy on the add-on electrode, while the energy on the built-in electrode is felt.	The add-on electrode malfunction. There is no contact between the plug and jack. The incompatible add-on electrode.	Replace the electrode. Check the connection between the add-on electrode plug and the SCENAR device jack. Use only the add-on electrodes supplied by the manufacturer of the SCENAR device.
There is no energy both on the add-on and built-in electrodes, when the add-on electrode is connected. While the energy on the built-in electrode is felt, if the add-on electrode is not connected.	Short circuit in the add-on electrode cable or plug. The incompatible add-on electrode.	Replace the electrode. Use only the external electrodes supplied by the manufacturer of the SCENAR device.
The SCENAR device turns off when there is a skin contact.	Bad skin contact or the skin is very dry.	Switch the SCENAR device ON and continue treatment of the target skin area. Repeat the switch-on when necessary.

8.2 Other malfunctions shall be serviced only by the manufacturer.

9 WARRANTY

9.1 The manufacturer guarantees that the SCENAR device complies with this Operating Manual when operated under the conditions specified.

9.2 The warranty period is 24 months from the date of purchase.

9.3 In case of malfunction during the warranty period, the SCENAR device with the Warranty card shall be returned to the manufacturer.

9.4 If the Warranty card is not provided, the Warranty seals are broken, or in case of mechanical damage to the SCENAR device no warranty claims shall be accepted and the warranty service shall not be performed.

9.5 The SCENAR device shall be repaired at the expense of the owner in the following cases:

- the SCENAR device was operated in disregard of instructions of the present Operating Manual;
- the manufacturer's seals are broken;
- there is mechanical damage to the SCENAR device;
- the warranty period has expired.

9.6 Customer claims shall be rejected if:

- the product has been subjected to any mechanical damage resulting from an accident, fire, acts of nature, or Force Majeure;
- the manufacturer's serial numbers, labels, seals are damaged or removed, or any other labeling identifying the product is damaged or removed;
- the seals are broken or the product contains any other signs of unauthorised access (repair);
- the product contains the defects resulting from:
 - ◆ improper transportation and storage conditions (no original package during the transportation, hyperhumidity, aggressive environment, any signs of foreign objects, animals and insects, liquid damage, etc.);
 - ◆ improper operating conditions (overload, mechanical, thermal or electric damages, bent contacts, cracks, spallings, dints and impact marks, completely or partially changed shape of the SCENAR device);
 - ◆ using low quality or inappropriate accessories.

10 TRANSPORTATION AND STORAGE

10.1 The transportation of the SCENAR devices to a customer may be carried out by all kinds of covered vehicles, except for the plane compartments that have no heating, at the air temperature from $-50\text{ }^{\circ}\text{C}$ to $+50\text{ }^{\circ}\text{C}$ and relative humidity 100 % at a temperature of $25\text{ }^{\circ}\text{C}$ with a protection from a direct atmospheric precipitation.

10.2 After transportation at negative temperatures, the SCENAR device should be kept in the transport container under normal climatic conditions for not less than 24 hours.

10.3 The SCENAR device shall be stored in the manufacturer's package in a heated room at a temperature of $5\text{ }^{\circ}\text{C}$ to $40\text{ }^{\circ}\text{C}$ and relative humidity of 80 % at $25\text{ }^{\circ}\text{C}$.

ANNEX 1

Guidance and manufacturer's declaration – electromagnetic compatibility (EMC)		
Intended healthcare environments – Professional and Home		
Emissions		
Classification		—
Standard	EN 55011 (idt CISPR 11)	
Class A or B	B	—
Group 1 or 2	1	—
Conducted RF Emissions		N/A NOTE 1
Radiated RF Emissions		PASS
Disturbance Power (if applicable)		N/A NOTE 2
Harmonic Distortion per EN 61000-3-2 (Class A, B, C, D)		N/A NOTE 1
Voltage Fluctuations and Flicker per EN 61000-3-3		N/A NOTE 1
Immunity		
Electrostatic Discharges EN 61000-4-2		PASS
Radiated RF EM Fields and Proximity Wireless fields EN 61000-4-3		PASS
Electrical Fast Transients and bursts EN 61000-4-4		N/A NOTE 3,4
Surges EN 61000-4-5		N/A NOTE 3,5
Conducted Disturbances, induced by RF fields EN 61000-4-6		N/A NOTE 3,4
Voltage Dips and Interruptions EN 61000-4-11		N/A NOTE 1
Rated Power-frequency Magnetic Field EN 61000-4-8		PASS
Supplementary information: NOTE 1) EUT is powered by internal battery 9V DC. NOTE 2) If applicable Radiated RF Emissions, Disturbance Power is not necessary. NOTE 3) The test is applicable to all d.c. power PORTS intended to be connected permanently to cables longer than 3 m. NOTE 4) SIP/SOPs whose maximum cable length is less than 3m in length are excluded. NOTE 5) This test applies only to output lines intended to connect directly to outdoor cables.		

Guidance and manufacturer's declaration – electromagnetic immunity		
Immunity test	EN 60601-1-2 test level	Compliance level
Electrostatic discharge (ESD) EN 61000-4-2	± 8 kV contact ± 2 kV, ± 4 kV, ± 8 kV, ± 15 kV air	PASS
Radiated RF EM fields EN 61000-4-3	3 V/m (for Professional Healthcare Facility Environ- ment) 80 MHz to 2.7 GHz 80 % Am at 1 kHz 10 V/m (for Home Healthcare Environment) 80 MHz to 2.7 GHz 80 % Am at 1 kHz	PASS PASS
Enclosure port immunity EN 61000-4-3	EN 60601-1-2:2015 Table 9	PASS
Power frequency (50/60 Hz) magnetic field EN 61000-4-8	30 A/m	PASS